

Dialogannahme

# ADAS CALIBRATION

Version 2024.05.03 – Prices on request

## 2-in-1 XXL calibration board | for VW front camera and multi-brand radar | Q.DAS

2-in-1 XXL calibration board with the pattern for calibrating front camera systems on VW Group vehicles. The newly reworked version in combination with Q.DAS allows users to also calibrate radar systems on all vehicles that require an even reflective service in front of the radar sensor. This enables radar calibration also on vehicles outside the VW Group.

**Article number: 8 900 381 056**

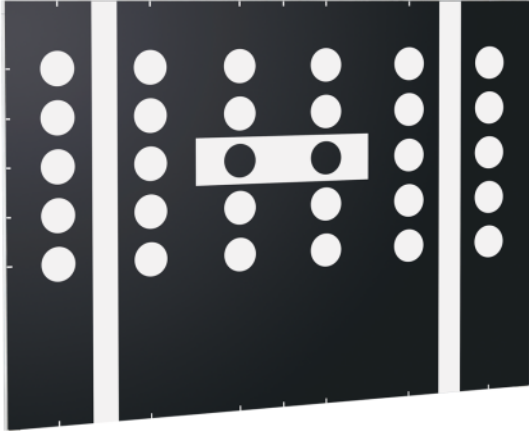

2-in-1 XXL calibration board with the pattern for calibrating front camera systems on VW Group vehicles. The newly reworked version in combination with Q.DAS allows users to also calibrate radar systems on all vehicles that require an even reflective service in front of the radar sensor. This enables radar calibration also on vehicles outside the VW Group. Single and double radar systems can be calibrated in the lowest height position, without any setup times or rotation of the target board. The height is infinitely adjustable to cover both low positioned radar systems as well as high positioned camera systems with only one calibration board. The purchase of the XXL calibration board does not require any further ACC reflector mirrors (8 900 381 150) for radar calibration! The required tilting positions are also possible with the XXL calibration board. Advantages:

- Camera calibration for VW Group vehicles and multi-brand OEM radar calibration in one
- No setup times, no rotation
- For single and double radars
- For passenger cars and transporter (very high transporters may only work in combination with Q.DAS Pro)
- Integrated tilting mechanism with 3 positions
- High quality materials and finishing with flat surface guarantee

Note: Only in combination with the Q.DAS frame.

## eTarget Kit | Digital 15-in-1 solution

15-in-1 calibration patterns in one eTarget for faster and error-free target board selection.

**Article number: 8 900 380 011**

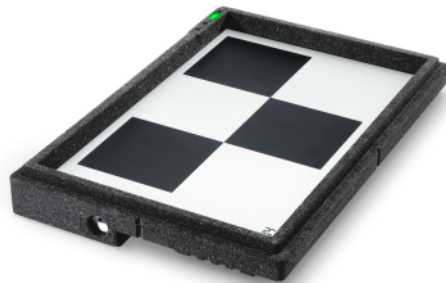

eTarget: fast and space-saving solution for workshops – broad manufacturer coverage includedeTarget is an innovative digital calibration target based on e-paper technology - unlike conventional monitors, beamers or other screen solutions.OEM-compliant calibration targets for precise and fast ADAS calibration with Q.DAS:

- Faster setup times, more space: 15 patterns in one eTarget
- Automatic pattern selection minimizes user errors
- Extremely high contrast, even from different viewing angles
- Reflective technology for all lighting conditions
- Integrated Bluetooth module for app communication
- Lightweight and robust housing
- Downward compatible with previous Beissbarth calibration solutions (BBFAS 1xxx, BBFAS 415)
- Battery operated and power saving – display is maintained even without power

Scope of deliveries:

- 2x eTarget with charging cable
- 1x Universal Type 4S (8 900 382 570)

Note: Automatic target selection requires active license for Q.mApp software.

## Multi-Target starter kit 1

For articles to be ordered, see configuration. | Article number: 8 900 381 001



- Multi-Target starter kit 1 with storagebox

### Targets included:

- Nissan Set 1 (8 900 381 139)
- Toyota (8 900 382 287)
- Mercedes 1 / Infiniti 2 (8 900 382 312)
- Mazda 1 (8 900 382 318)
- Honda 3 (8 900 382 349)
- Toyota 3 (8 900 382 355)
- Universal Target 1 (8 900 382 570)

## Multi-Target starter kit 2

For articles to be ordered, see configuration. | Article number: 8 900 381 002



- Multi-Target starter kit 2 with storagebox

### Targets included:

- Mercedes 1 / Infiniti 2 (8 900 382 312)
- Mercedes 2 (8 900 382 319)
- Universal Target 1 (8 900 382 570)

# Calibration target set Nissan type 1

Article number: 8 900 381 139

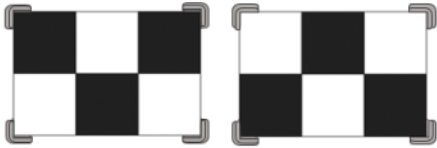

## Nissan

- Qashqai [J11] year from 2013 to 2017-09
- Qashqai Facelift [J11] year from 2017-10
- X-Trail / Rouge [T32] Facelift year from 2017

## Calibration target set Nissan type 2

Article number: 8 900 381 140

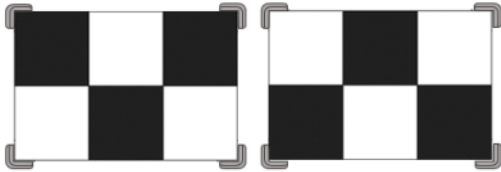

### Infiniti

- QX60 formerJX [L50]
- QX70 [Y51] = FX\_Serie year from 2013

### MERCEDES-BENZ

- X-Klasse [470, 471] year from 2017

### Nissan

- Altima [L34] year from 2019
- Leaf [ZE1] year from 2018
- Maxima [A36] year from 2016
- Maxima [A36] year from 2015 to 2016
- Micra [K14] year from 2017
- X-Trail / Rouge [T32] year from 2013 to 2016

# Calibration target set Honda type 1

Article number: 8 900 381 143

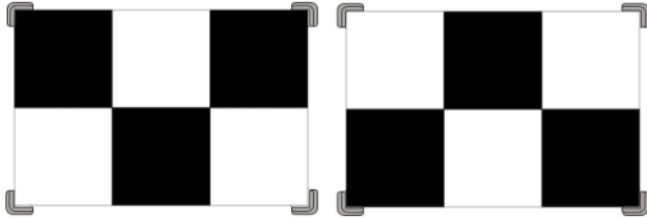

## Honda [EU]

- Jazz / Fit [GK] year from 2015
- Civic (9) year from 2012 to 2016
- Civic Typ KG : year from 2016 to 2017
- HR-V [RU] year from 2015

## Honda [US]

- Accord US year from 2013 to 2015
- Civic (5 door) year from 2016 to 2017
- Civic (Hybrid) year from 2012 to 2015
- CR-V year from 2017
- HR-V year from 2016 to 2017



# Calibration target Honda type 2

Article number: 8 900 382 297



## Calibration target Honda type 3

Article number: 8 900 382 349



### Honda [EU]

- Accord (9) [CR] year from 2014
- Civic Non KG: year from 2016 to 2017
- CR-V (4) [RM] year from 2012 to 2015
- CR-V (4) [RM] year from 2015 to 2017

# Calibration target Mazda type 1

Article number: 8 900 382 318



## MAZDA

- CX 3 [DK] year from 2015
- CX 5 [KE] year from 2012 to 2016
- CX 9 [TB]
- MX5 [ND]
- Serie-2 [DJ, DL]
- Series-3 [BM] year from 2013 to 2016-05
- Series-6 [GJ] year to 2016

## Calibration target set Mazda type 2

Article number: 8 900 381 234

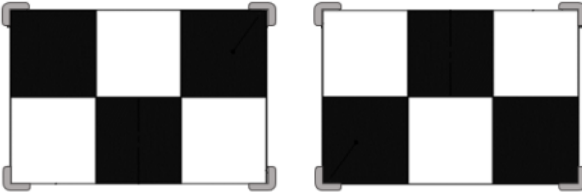

### MAZDA

- CX 5 [KF] year from 2017
- Series-3[BN] year from 2016-06
- Series-6 [GL] year from 2017

# Calibration target set Mitsubishi type 1

Article number: 8 900 381 218

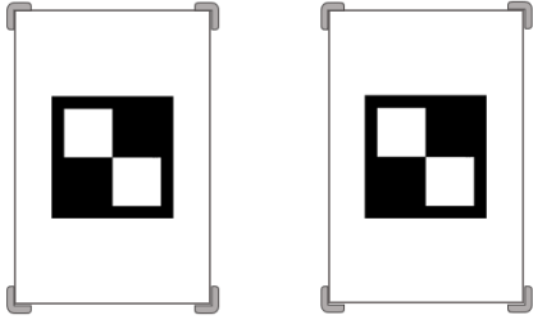

## MITSUBISHI

- ASX / Outlander Sport [GA] year from 2018
- Eclipse Cross [GK] year from 2018
- Outlander III Facelift / PHEV year from 2017

# Calibration target Toyota type 1

Article number: 8 900 382 287



## LEXUS

- ES300h ES450h [V6#] year from 2012 to 2015
- GS-F, GS200t, GS250, GS300h GS350 GS450h [L1#] year from 2012
- LS460, LS600h [F4#] year from 2007
- NX200 NX300h [Z1#]
- RC-F, RC200t, RC350 [C1#] year from 2014

## TOYOTA

- Auris / Corolla [E18#] with SafetySense 3-Step year from 2015 to 2018
- Avensis [T27#] with SafetySense 3-Step year from 2015
- Aygo [B4#] with SafetySense 3-Step year from 2015
- Camry [V5#] year from 2014
- C-HR X10/X50 year from 2017
- Highlander, Kluger [U5] year from 2013
- Mirai [JPD10] year from 2015
- Prius [W30] Prius [W40] year from 2009 to 2015
- RAV4 [A4] year from 2012 to 2015
- Verso [R2#] with SafetySense 3-Step year from 2016
- Yaris [P13#] with SafetySense 3-Step year from 2015 to 2017
- Yaris [P13#] with SafetySense 3-Step year from 2017

## Calibration target Toyota type 2

Article number: 8 900 382 328



### CITROEN

- C1 [B4] year from 2014

### PEUGEOT [EU]

- 108 [B3]

### TOYOTA

- Auris / Corolla [E18#] with SafetySense 1-Step year from 2015 to 2018
- Avensis [T27#] with SafetySense 1 -Step year from 2015
- Aygo [B4#] with SafetySense 1-Step year from 2015
- Verso [R2#] with SafetySense 1-Step year from 2016
- Yaris [P13#] with SafetySense 1-Step year from 2015 to 2017
- Yaris [P13#] with SafetySense 1-Step year from 2017

## Calibration target Toyota type 3

Article number: 8 900 382 355



### LEXUS

- ES300h ES450h [V6#] year from 2015
- IS200t IS300h IS350 [E3#]
- LS500h LS600h [F5#] w Mono-Front-Camera year from 2017
- LS500h LS600h [F5#] w Stereo-Front-Camera year from 2017
- LX570 [J20] year from 2007
- RX200t, RX350, RX450h, [L2#] year from 2015-09

### TOYOTA

- Hilux\_[N12, N13] year from 2015
- Prius [W50] year from 2015
- RAV4 [A4] year from 2015 to 2018



## Calibration target Subaru type 2S

*With slot for the alignment laser*

**Article number: 8 900 382 608**

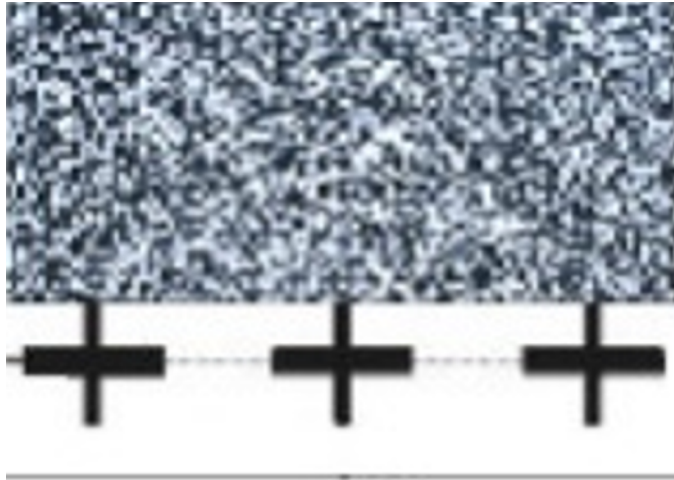

### SUBARU

- Forester G3 (AUS), [SH /S13] year from 2012
- Forester G4 (AUS), [SJ] year from 2014
- Impreza G4 (AUS), [GJ,GP/G23] year from 2011 to 2015
- Legacy [BM,BR / B13] year from 2012
- Outback [BR / B14] year from 2012 to 2015
- XV / Crosstrek [GP, G33] year from 2011 to 2015

## Calibration target Subaru type 3S

With slot for the alignment laser

**Article number: 8 900 382 590**



### SUBARU

- Impreza G4, [GJ,GP/G13] year from 2011 to 2017
- Impreza G5 , [GK,GT] year from 2018
- Legacy [BN,BS] year from 2014
- Levorg [GP / V10,VM] year from 2014
- Liberty (au) [BN] year from 2014
- Outback [BR / B14] year from 2015
- Outback [BS /B15] year from 2014
- WRX [VA /V10] year from 2014
- XV / Crosstrek [GP, G33] year from 2015

## Calibration target Kia / Hyundai type 2

Article number: 8 900 382 320

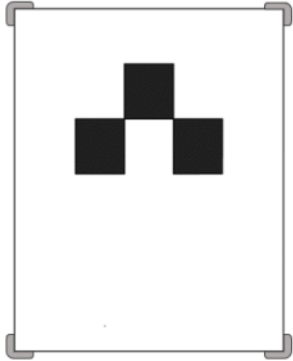

### Hyundai

- H350 [EU] year from 2015

## Calibration target Kia / Hyundai type 3

Article number: 8 900 382 316



### Hyundai

- Equus [VI] year from 2016
- Genesis [BH] year from 2011 to 2014
- SantaFe [DM] Grand-SantaFe [NC] Sport-SantaFe MaxCruise [NC] year from 2015

### KIA

- Cadenza / K7 [VG] year from 2009 to 2016
- Sorento [XM] year from 2009 to 2015

# Calibration target Mercedes/Infinity type 1

Calibration target for Mercedes (passenger cars)

**Article number: 8 900 382 312**



## MERCEDES-BENZ

- A-Klasse [176] year from 2012 to 2018
- B-Klasse [246] year from 2011-11 to 2018-11
- C-Klasse [204] +Facelift year from 2007 to 2014
- C-Klasse [205] year from 2014
- CL [216] year from 2006 to 2013
- CLA [117] year from 2013 to 2019
- CLS [218] year from 2011 to 2018
- E-Klasse [212] year from 2012 to 2016
- E-Klasse [213] year from 2016
- E-Klasse Coupe [207] year from 2009 to 2016
- E-Klasse Coupe [238] year from 2016
- GLA [156] year from 2013 to 156]
- GLC [253] year from 2015
- GLE [292] year from 2015 to 2019
- GLK [204] + Facelift year from 2008 to 2015
- M-Klasse (GL-Klasse) GLE, GLS [166] Camera system 4.0.1 year from 2011 to 2015
- M-Klasse (GL-Klasse) GLE, GLS [166] Camera system 4.0 year from 2011 to 2015
- M-Klasse [GL-Klasse] [164] year from 2006 to 2012
- S-Klasse [221] year from 2005 to 2013
- S-Klasse [222] year from 2013
- S-Klasse Coupe [217] year from 2014 to 217]
- SLK, SLC [172] year from 2011
- SL-Klasse [231] year from 2012
- SLR [190] year from 2014 to 2016
- V-Klasse[447] / Vito [448] year from 2014

## Calibration target Mercedes / Infinity type 2

Calibration target for Mercedes (Sprinter) / Infinity

**Article number: 8 900 382 319**

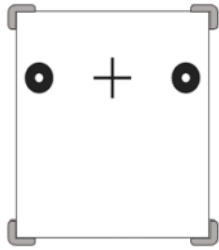

### MERCEDES-BENZ

- Sprinter [W909] year from 2013 to 2019
- Sprinter 2500 / 3500 [W906] year from 2006 to 2013

### VOLKSWAGEN

- Crafter [2E,2F] year from 2016 to 2017

# Calibration target Universal type 6S

With slot for the alignment laser

Article number: 8 900 382 571



## CITROEN

- C3 Aircross [A88] year from 2017
- DS3 Crossback [D34] year from 2019
- DS7 Crossback [X74] year from 2017
- Jumper 3 / Relay 3 [U9] year from 2014

## FIAT

- 500X [334] year from 2015
- Ducato year from 2014

## Hyundai

- Elantra [ADA] year from 2017
- Genesis [DH] year from 2014
- i10 [IA] year from 2017
- i20, i20 Active [GB] year from 2015
- i30 [GD] year from 2015
- i30 [PDE] year from 2017
- i40 [VF] year from 2012
- IONIQ [AE-HEV] year from 2017
- SantaFe[DM] year from 2016
- Sonata [LFA] year from 2016
- Tucson [TL] year from 2016

## Jeep

- Renegade [BU] year from 2015

## KIA

- Cadenza / K7 [YG] year from 2016
- Carens / Rondo [RP] year from 2014
- Ceed / Pro Ceed [JD] year from 2013
- Niro [DE] E-Niro year from 2017
- Optima [JF] year from 2016

- Optima [TF] year from 2015
- Rio (YB) year from 2017
- Sorento [UM] year from 2015
- Soul [PS] E-Soul year from 2015

## OPEL

- Crossland X year from 2017
- Grandland X year from 2018

## PEUGEOT [EU]

- 3008 II year from 2018
- 508 II year from 2018
- Boxer-3 / Manager [U9]

## TESLA

- Model S year from 2016-10
- Model X year from 2016-10

# Calibration target set Universal type 2

Article number: 8 900 381 142

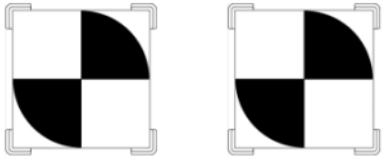

## NISSAN

- Cima; Fuga [Y51] = Infinity Q70
- NV400 [X62]
- Patrol [Y62] year from 2010

## OPEL

- Movano-B

## RENAULT

- (Grand) Espace V [xFC] year from 2015
- (Grand) Scenic III [J95] year from 2012
- Kadjar [HL/ HZH, HFE] year from 2015 to 2018
- Koleos II [HZG, HZJ] year from 2016
- Master III [x62] year from 2010
- Megane III [x95] year from 2008
- Megane IV [xFB] year from 2016
- Talisman [xFD] year from 2015
- Twingo III [B07] year from 2014

## SMART

- ForFour [543.0] year from 2014
- ForTwo [543-3-4] year from 2014



## Target storage box empty

Article number: 1 690 381 217



- Empty storagebox for storing the multi brand targets for front camera calibration.

## ACC reflector mirror | for radar calibration

ACC reflector mirror for adjusting the ACC sensor.

**Article number: 8 900 381 150**

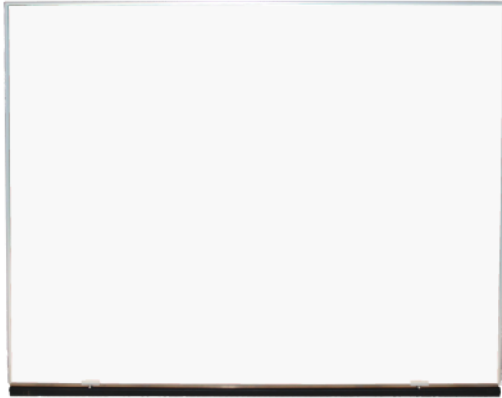

## BBFAS 1415

Article number: 8 900 380 007

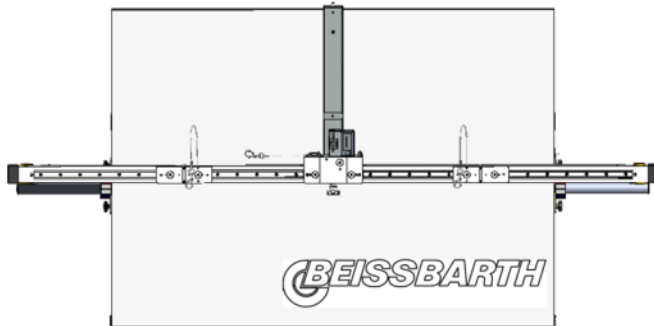

- Comprehensive coverage of the front camera calibration will be achieved by upgrading the system with the BBFAS 1415. In combination with the optional calibration targets the service can be extended for all important European, Japanese and Korean vehicle manufacturers.
- You simply need to mount the precision measurement bar, which is able to carry the calibration targets, on the BBFAS 1000 base frame and you are ready to go. Precise orientation of the frame and the target relative to the driving axle is made possible with the Beissbarth 3D wheel alignment system or with Beissbarth CCD system.

## Target Shop



**2-in-1 XXL calibration board | for VW front camera and multi-brand radar | Q.DAS**  
Article number: 8 900 381 056



**eTarget Kit | Digital 15-in-1 solution**  
Article number: 8 900 380 011



**Multi-Target starter kit 1**  
Article number: 8 900 381 001  
For articles to be ordered, see configuration.



**Multi-Target starter kit 2**  
Article number: 8 900 381 002  
For articles to be ordered, see configuration.



**Calibration target set Nissan type 1**  
Article number: 8 900 381 139



**Calibration target set Nissan type 2**  
Article number: 8 900 381 140



**Calibration target set Honda type 1**  
Article number: 8 900 381 143



**Calibration target Honda type 2**  
Article number: 8 900 382 297



**Calibration target Honda type 3**  
Article number: 8 900 382 349



**Calibration target Mazda type 1**  
Article number: 8 900 382 318



**Calibration target set Mazda type 2**  
Article number: 8 900 381 234

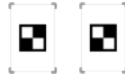

**Calibration target set Mitsubishi type 1**  
Article number: 8 900 381 218



**Calibration target Toyota type 1**  
Article number: 8 900 382 287



**Calibration target Toyota type 2**  
Article number: 8 900 382 328



**Calibration target Toyota type 3**  
Article number: 8 900 382 355

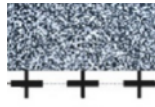

**Calibration target Subaru type 2S**  
Article number: 8 900 382 608

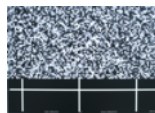

**Calibration target Subaru type 3S**  
Article number: 8 900 382 590



**Calibration target Kia / Hyundai type 2**  
Article number: 8 900 382 320



**Calibration target Kia / Hyundai type 3**  
Article number: 8 900 382 316



**Calibration target Mercedes/Infiniti type 1**  
Article number: 8 900 382 312



**Calibration target Mercedes / Infiniti type 2**  
Article number: 8 900 382 319



**Calibration target Universal type 6S**  
Article number: 8 900 382 571



**Calibration target set Universal type 2**  
Article number: 8 900 381 142



**Target storage box empty**  
Article number: 1 690 381 217

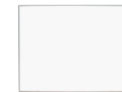

**ACC reflector mirror | for radar calibration**  
Article number: 8 900 381 150



**BBFAS 1415**  
Article number: 8 900 380 007

# IMPORTANT NOTES

- Please notice: This list contains spare parts, too.
- Without instruction or assembly.
- Delivery ex works including packaging.

## VERSION 2024.05.03 – PRICES ON REQUEST

- Starting from now all previous lists will lose their validity.
- Please read our general terms and conditions in the latest version before ordering; to be found under [www.beissbarth.com](http://www.beissbarth.com).

**Order number** 1 693 602 008 **Print norm** BB XXX / XX.XX.2020 DE · Subject to technical and program changes, errors excepted.

### Beissbarth Automotive Testing Solutions GmbH

Hanauer Straße 101  
80993 Munich, Germany  
[sales@beissbarth.com](mailto:sales@beissbarth.com)  
[www.beissbarth.com](http://www.beissbarth.com)

Telefon: +49-(0)89-14901-0  
Telefax: +49-(0)89-14901-246

